



Polygal Inc. Hurricane Panel Installation Instructions-POLYGAL 16mmSG SHEET.

Tested in accordance with FBC-204 – TAS 201, 202, 203; 2003 ICC, IRC, IBC; ASTM E 1886-02, E 1996-02; ASTM E 330-02

READ ALL INSTRUCTIONS BEFOR STARTING

1. *Not for openings larger than 66” x 90”.*
2. *Maximum sheet size 72” x 96”.*
3. *Sheets must be attached on all four sides in accordance with these instructions.*
4. *Sheets must overlap opening a minimum of 3” on all four sides.*

Step 1 – **16mm SG sheets** – Cut sheet width and length to **overlap opening on all sides 3”**. (Sheet “length” is the direction of flutes). ***Exterior UV treated surface*** has printed masking. Mark the exterior surface with marker pen before removing the masking. Install sheets so that the exterior UV treated surface is the side exposed to the sun.

Step 2 – **2” U channel Cutting & Placement Sides** – Cut 2” U channel exact length of sheet for left and right sides of sheet. Place on left and right side of sheet flush with sheet. The angled surface of the U channel should be on the exterior surface of the sheet.

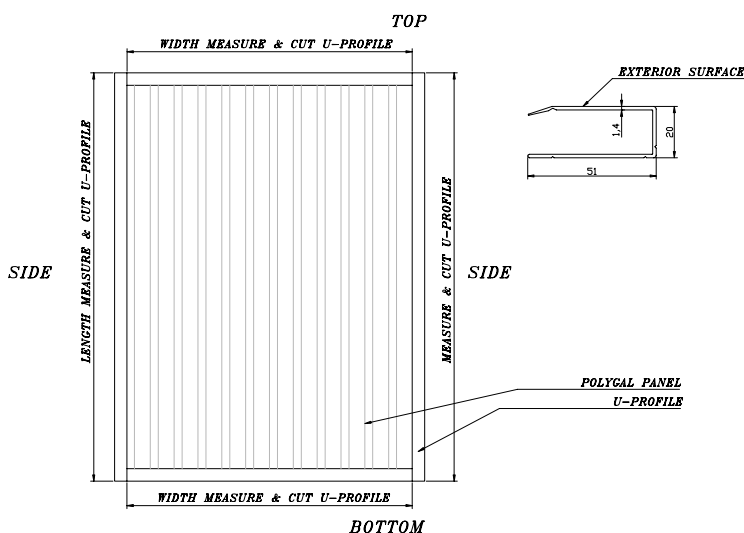

Step 3 – 2” U channel Cutting & Placement Top and Bottom -

Measure inside distance, along top and bottom of sheet between left and right U channels. Make sure left and right U channels are flush with sheet before measuring. Cut the U channel to length and place on both top and bottom flush with sheet. The angled surface of the U channel should be on the exterior surface of the sheet.



Step 4 – **Marking Corner Hole Points for Pre Drilling** – 1) Starting in the upper left hand corner, measure 1 ½” down from the top edge of the aluminum profile and 1 ½” from the left side of the sheet. Mark the drill point with a center punch, continue with the other three corners making sure you mark the point 1 ½” down/up and in from the edges. 2) Start in the upper left hand corner and measure 1 ½” down from the top edge of the aluminum profile and 3” from the left side of the sheet. Mark the drill point with a center punch, continue with the other three corners making sure you mark the point 1 ½” down/up and 3” from the left/right side of the sheet.

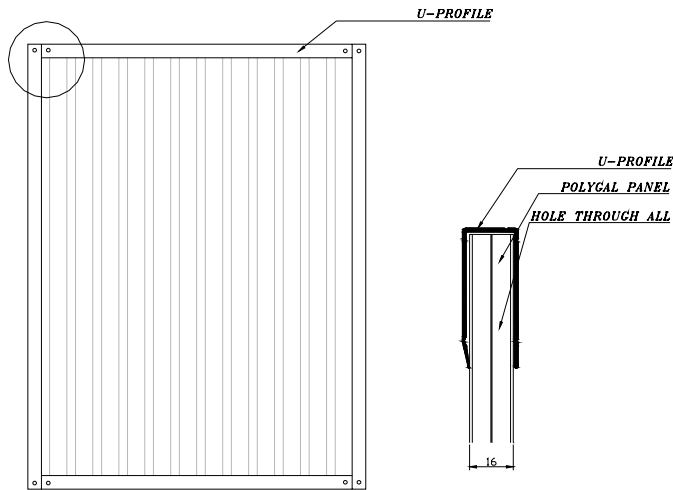

Step 5 – **Marking Fastening Holes 16mm SG** – Starting at the left corner 15” from the left edge, top and bottom of the sheet, working to the right, mark the aluminum 2” U channel with a center punch every 12” (make sure that all points marked are 1 ½” from the edge of the U channel toward the center of the sheet). Starting at the upper left corner 10 ½” down (1 ½” from the edge toward the center of the sheet), working down, mark the aluminum 2” U channel with a center punch every 12”.

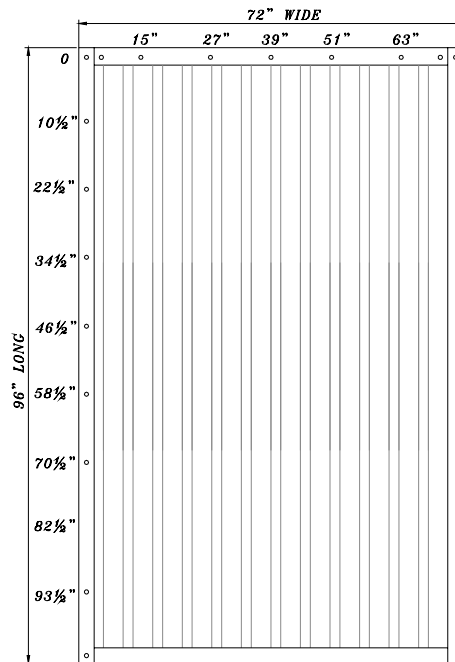



Step 6 – **Pre Drilling Fastening Holes** – Make sure the aluminum U channels are well seated against the sheet. Drill (9/16” drill bit) all marked points through the aluminum U channel top, polycarbonate sheet and aluminum U channel bottom.

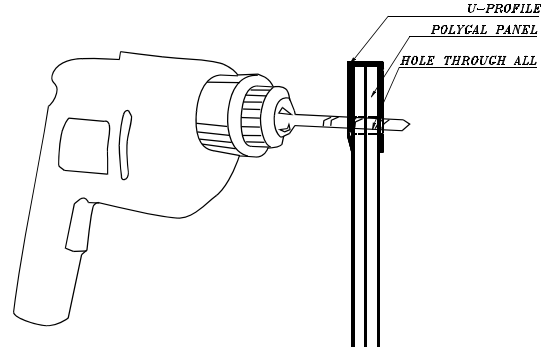

Step 7 – **Marking Wall Fastening Points** - With the help of another person use the pre drilled sheet as a template. Position the pre drilled sheet against the wall of the building making sure that it is square and level, **and that all sides overlap the opening 3”**. Using a marking pen, mark each pre drilled hole position on the concrete/wood wall.

Step 8 – **Mounting Hardware** – Using the “Sammys” manufacturers’ installation instructions, pre drill and counter sink 3/8” “Sammys Threaded Rod Anchoring System” flush with the concrete/wood wall. One anchor for each template mark made upon the wall in step 7. (Use SAMMYS 1-1/2” FOR 3/8” ROD #8059957 CST 20 FOR CONCRETE; Use SAMMYS 3” FOR 3/8” ROD #8010957 GST 30 FOR WOOD)

3” SAMMY for 3/8” Rod
GST 30 for Wood

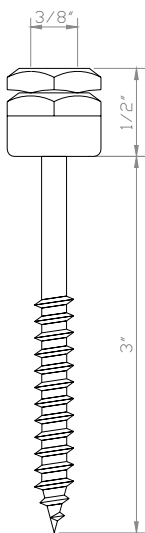

1-1/2” SAMMY for 3/8” Rod
CST 20 for Concrete

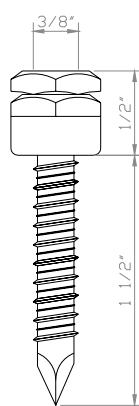

Washer

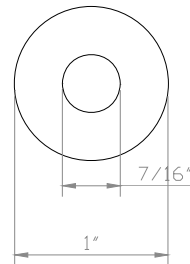

HCS 3/8” – 16 x 1 1/4”
Hex Bolt

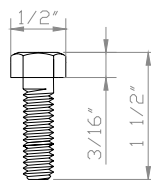

CF 3/8” – 16
Wing Nut

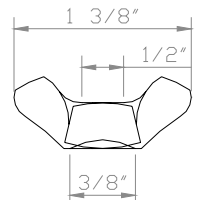

3/8” x 2” threaded
Steel Rod

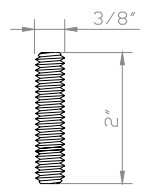



Step 9 – **Corner Posts** – Insert one 2” long 3/8” threaded rod into each of the four corner anchors and screw tight. These are used to initially hold the pre drilled sheet. Place the predrilled sheet onto the four corner rods, making sure the sheet fits flush with the wall. Place a 1” washer and 3/8” wing nut on each threaded rod and tighten enough to keep sheet from becoming dislodged.

Step 10 – **Fixing Posts/Bolts** – Using the empty pre drilled holes as a guide, insert a 2” threaded rod into each hole and screw tight. Place a 1” washer and 3/8” wing nut on each threaded rod. Tighten all wing nuts. As an option, in place of the 2” threaded rod, a 3/8” -16 x 1 1/4” Hex Head Cap Bolt and 1” washer can be used.

Step 11 – **Uninstall** – To uninstall, remove wing nuts and Hex Head Cap Bolts and washers. Remove sheet and store in a protected space. Replace all washers, wing nuts and/or Hex Head Cap Bolts into the “Sammy’s” for future reinstallation.

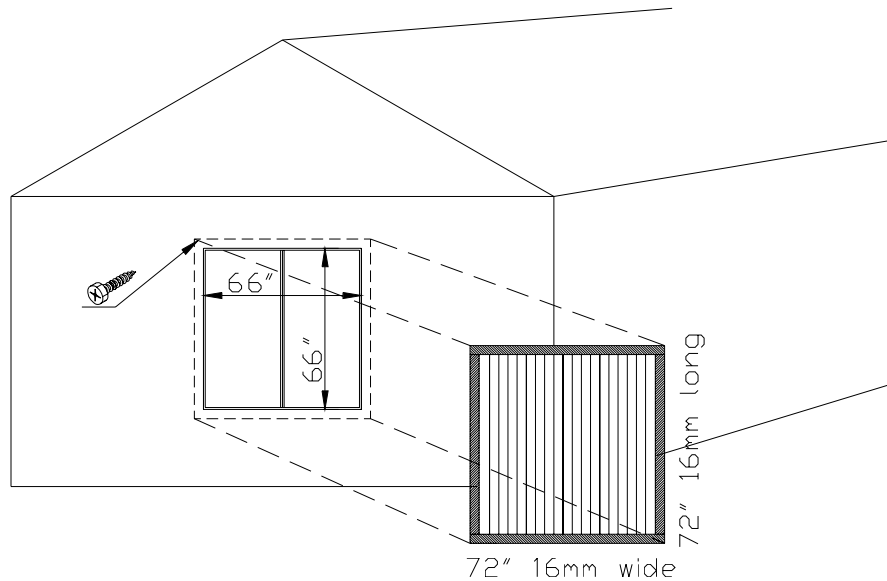

The information above relates specifically to PCSS 16mmSG made from a particular polycarbonate resin and is not relevant to any similar generic product. No liability is accepted for any loss or damage from the use of this data which is given in good faith, but without commitment, and no warranty is given or implied. Polycarbonate is a combustible thermoplastic. Avoid exposure to excessive heat or to aromatic solvents. Precautions used to protect other common combustibles should be followed. The values presented were obtained in laboratory conditions and represent test averages. Polygal retains the right to change said values without notice should future testing results dictate value changes.